

Revised



# RIGGING SAFETY GUIDE

Proper Rigging for Mechanical Construction and Service





# RIGGING SAFETY GUIDE

## Forward

Experienced mechanical construction and service workers are experts in pipefitting, plumbing, or mechanical service work, but not necessarily in rigging. However, many of these workers perform rigging as a part of their regular work routine. Therefore, they do need some knowledge in safe rigging practices for the types of rigging they perform on a regular basis. Additional knowledge or refresher information on some of the key safe rigging practices provided by this guide will help these workers:

- Prevent rigging/lifting related injuries;
- Prevent damage to equipment, materials and property; and
- Perform their rigging responsibilities more effectively.

This guide is intended to help the user include safety in the planning and actual practice of rigging mechanical industry equipment and materials for lifting operations.



## Introduction

The three main parts to any load lifting operation are the lifting equipment (crane/derrick/hoist), the operator/operation of the equipment, and the rigging of the load. This guide focuses on the rigging of the load. Specifically, it addresses how mechanical construction and service workers can safely rig the types of loads that are most common in our industry.

This guide does not cover all there is to know about rigging. While most mechanical construction and service workers are not rigging experts, many of them become skilled at safely rigging the materials and equipment used in the mechanical industry.

Ten basic rules for safe mechanical industry rigging operations are described in this guide. By learning the basic concepts behind each rule and following the rules while participating in mechanical industry rigging operations, mechanical industry riggers will help keep themselves and others in the work area safe from rigging related hazards.

Basic rigging safety for *routine lifts* in mechanical construction and service industry applications are covered in this guide. *Critical lifts* are not routine lifts and require considerable professional expertise in lifting equipment, operation of the equipment, rigging, and critical lift planning. Critical lifts may include, but are not necessarily limited to lifts involving multiple cranes, lifts over operating facilities, lifts close to power lines, lifts that exceed the designated percentage of the rated capacity (usually between 70% and 80%), lifts over occupied buildings, etc. Before participating in the rigging of a critical lift make sure that:

- A critical lift plan designed specifically for the critical lift that you will be involved with has been developed by a properly trained/qualified person;
- The most senior supervisor in charge of the lift, the equipment operator and the lead rigger have approved and signed off on the critical lift plan; and
- Your supervisor has verified that you are properly trained and qualified to participate in the critical-lift rigging process.

***This guide is not intended to provide exhaustive treatment on the subject of crane, derrick and/or hoist rigging operations as they pertain to the mechanical construction and service industry. Further, it is not intended to provide legal advice. Employers must make independent determinations regarding the need for legal assistance.***



## Table of Contents

Rule #1—Determine the Weight of the Load	7
Rule #2—Determine Proper Hitch Based on Load Type	9
Rule #3—Understand Angles & Tension on Slings/Hardware	13
Rule #4—Select the Right Sling Based on Load Type	15
Rule #5—Select the Right Hardware for the Load	20
Rule #6—Inspect Each Sling Before You Use It	23
Rule #7—Inspect Rigging Hardware Before You Use It	28
Rule #8—Protect Slings from Cuts and Tears	30
Rule #9—Determine the Load’s Center of Gravity	31
Rule #10—Pay Close Attention to Detail at Lift Time	32
Appendix A—Safety Tips for Common Industry Rigging Applications	34
Appendix B—Pre-Lift Reminders for Riggers	46
Appendix C—Hand Signals for Crane Operations	47



## Rule # 1—Determine the Weight of the Load

The rated capacities of cranes/derricks/hoists and rigging equipment are of little practical use if you do not know the weight of the load that is to be rigged and lifted. In some cases it will be rather obvious that the load is too light to exceed lifting and rigging equipment- rated capacities. However, there will be cases when you are uncertain whether the load can be lifted safely. That is when you need to establish the weight of the load and compare it to the rated capacities of the lifting equipment, sling or slings, and rigging hardware. Here is how to determine the weight of the materials most commonly rigged for lifting in the mechanical industry.

### Pipe

Pipe weights are standardized by material and wall thickness. Manufacturers often paint the weight per foot on the pipe making weight calculations simple. You can also use pipe charts when they are available, but when necessary, calculate the weight of steel pipe by using the formula below. If there are multiple pieces of the same size and type of pipe, remember to multiply the weight of one piece by the total number of pieces. For various sizes/types of pipe, calculate the weight of each piece and add them together.

#### Weight of Steel Pipe = $\text{Pi} \times \text{D} \times \text{L} \times \text{T} \times (\text{Unit Weight})$

Key	What It Means
Pi	3.14
D	Diameter of the pipe
L	Length of the pipe
T	Thickness of the steel
Unit Weight	The unit weight provided by the manufacturer or supplier

In the following example, we will calculate the weight of a single piece of steel pipe.

#### Weight of Steel Pipe = $\text{Pi} \times \text{D} \times \text{L} \times \text{T} \times (\text{Unit Weight})$

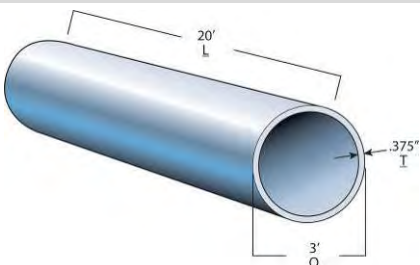
Key	What It Means	Illustration
Pi	3.14	
D	3 feet	
L	20 feet	
T	.03125 feet (.375 inches divided by 12)	
Unit Weight	189.57 pounds/foot	

Using the formula and numbers above, we determine that this piece of pipe weighs 1,116 pounds ( $3.14 \times 3' \times 20' \times .03125' \times 189.57 = 1,116$ ).



## HVAC Units/Equipment

In some cases the weight will be listed on the equipment. Otherwise obtain the weight from the manufacturer or supplier. Request the specifications of the equipment in writing and confirm that they match the brand and model number of the equipment to be rigged.

## Pumps, Fans, Welding Machines, Boilers, and Miscellaneous Equipment

Check the specifications provided by the manufacturer or supplier for the weight of the object or objects. If that information is not available at the jobsite, contact the manufacturer or supplier and give them the brand and model number of the equipment. Request the specifications in writing and confirm that the specifications match the brand and model number of the equipment that will be rigged/lifted.

## Compressed Gas Cylinders

Determine whether the cylinders are empty or full and multiply the number of cylinders by the proper weight. Remember to add the weight of the cage to the total weight of the cylinders.

### Typical Cylinder Weight Examples

These are sample weights and should not be used for your load weight calculations. Obtain cylinder weights from your supplier. Also, be sure to use approved cylinder handling cages/devices when lifting compressed gas cylinders.

Size	Weight – Empty	Weight – Full
Large	220 pounds	240 pounds
Medium	115 pounds	170 pounds
Small	60 pounds	75 pounds

## **Rule # 2—Determine Proper Hitch Based on Load Type**

A rigging hitch is used to attach the sling to the load. There are three basic types of hitches: the vertical hitch, choker hitch, and basket hitch. It is critical that the hitch you select will safely support the load.

For example, a single choker hitch would not provide full support for a stack of loose pipe. When the lift starts and the sling tightens, it would become taut around the bottom and sides of the stack, but the pipe on top of the stack would remain loose. A much safer choice for a stack of loose pipe would be a 2-sling double wrap choker hitch or a 2-sling double wrap basket hitch, which would secure the pipe for lifting.

The illustrations on the following pages show the proper applications for hitches that are commonly used in our industry.

**2-Leg Bridle Hitch (Single Piece)**

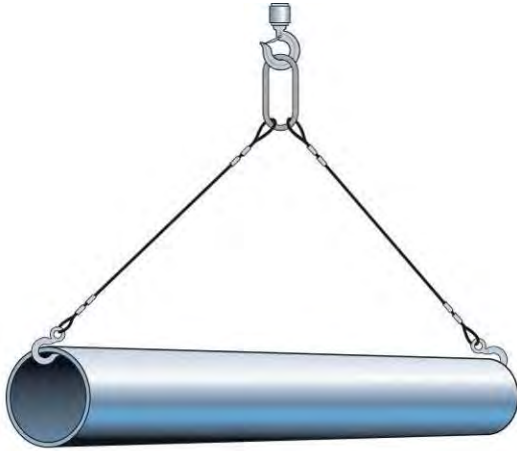

**Single Choker Hitch  
Short Pipe/Fittings (Single Piece)**

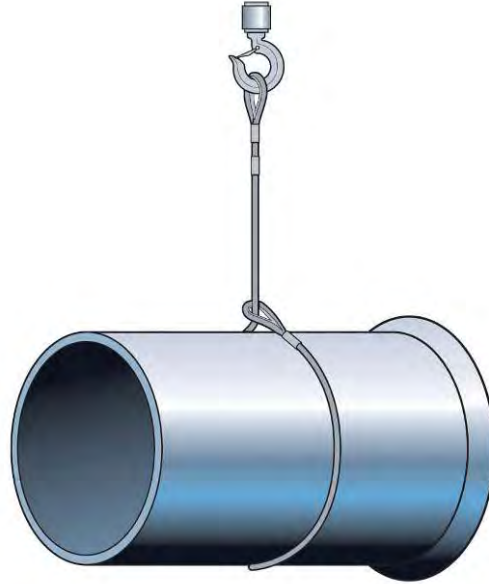

**Double Choker Hitch  
Longer Pipe (Single Piece)**

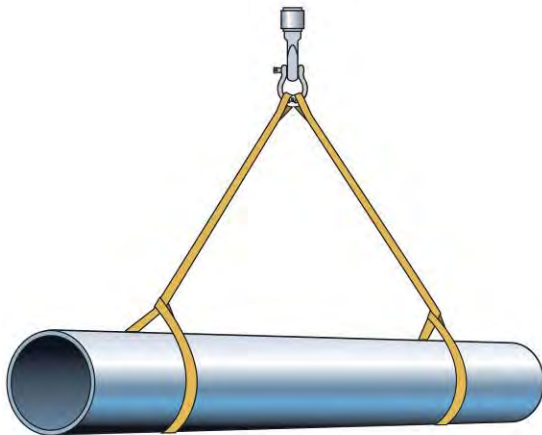

**2-Sling Double Wrap Choker Hitch  
(Multiple Pieces)**

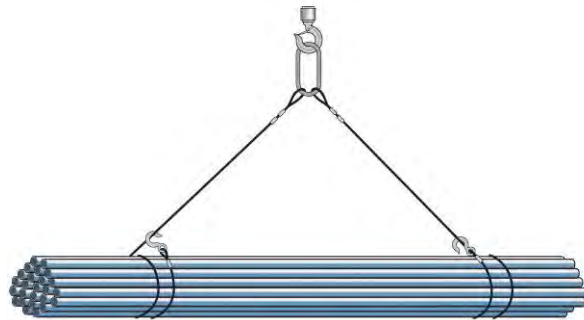

**2-Sling Double Wrap Basket Hitch  
(Multiple Pieces)**

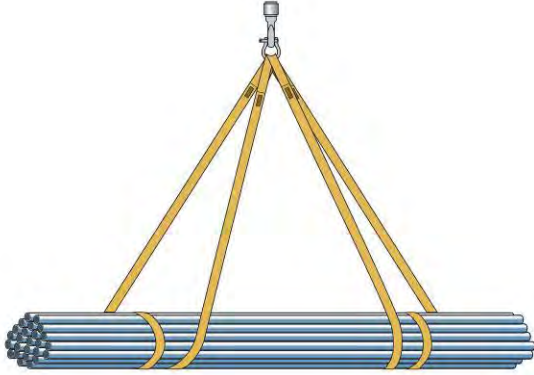

**2-Basket Hitch  
(Large Cylinders)**

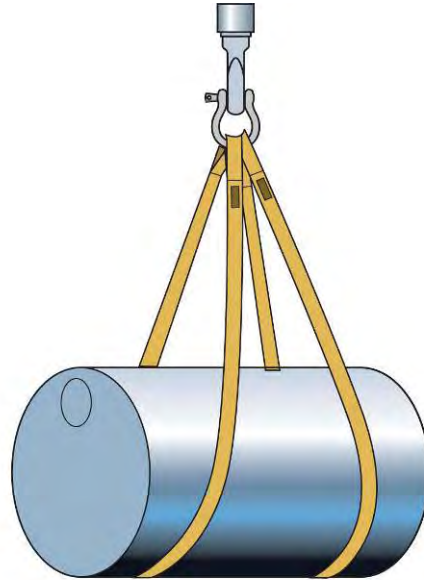

**Single Vertical Hitch  
(Various Applications)**

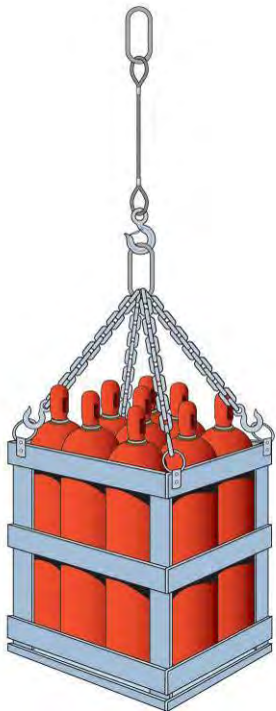

**Spreader Bar  
(Taller HVAC Units/Equipment)**

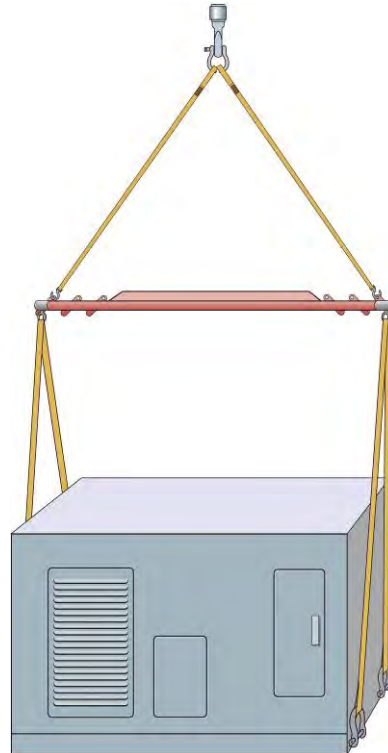

**4 Slings/Shackles**

## (Shorter HVAC Units/Equipment)

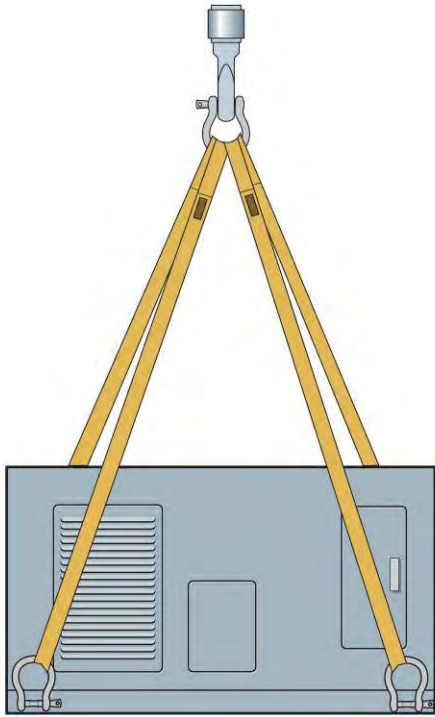

## Rule # 3—Understand Angles & Tension On Slings/ Hardware

One of the most important things to remember about sling tension is that the lower the angle between the load and the sling, the higher the tension on the sling. Angles also increase the tension on hardware. Hardware's rated capacity decreases when it is pulled from any direction other than vertical. This is critical information for proper sling and hardware selection and proper use.

### Sling Angle/Tension Examples

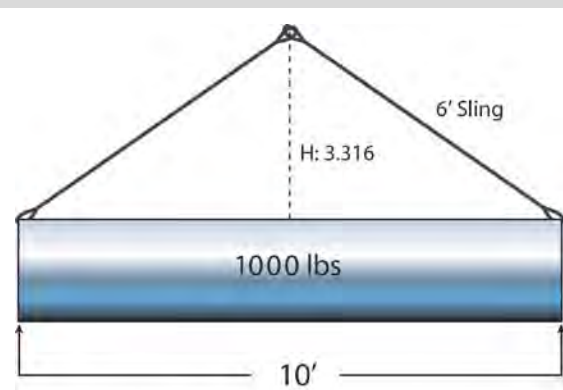

$$\text{Sling Tension} = \frac{(WT) \times (L)}{2 \times H}$$

905 pounds of force per sling

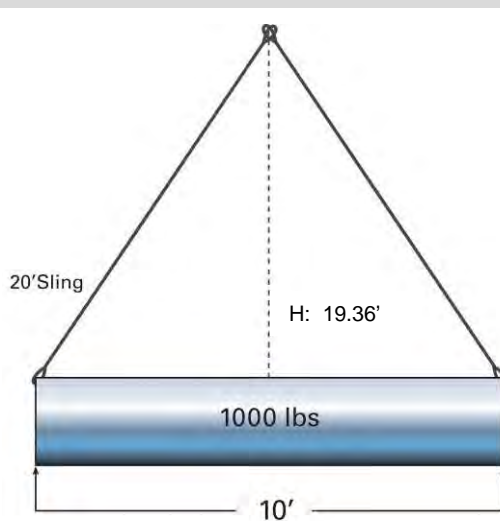

517 pounds of force per sling

### Hardware Examples

Continuous reduction in percentage of rated capacity as the angle increases. Check with the manufacturer for details.

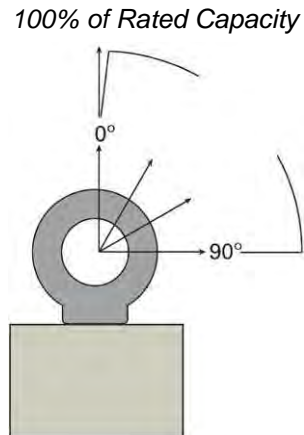

Continuous reduction in percentage of rated capacity as the angle is increased and load moves out from center of hook.

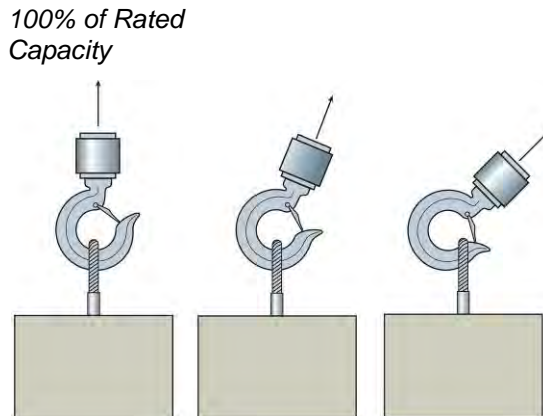

## Multi Leg Slings

Be sure to consider the number of legs on multi leg slings when determining sling tension and rated capacity.

- Each leg of a two leg sling shares the load.
- Each leg of a three leg sling shares the load.
- On a four leg sling only two of the legs may be carrying the majority of the load. The other two legs balance the load.
- Make sure the rated capacity of each sling is adequate for the load.

### 2-Leg Slings Share the Whole Load

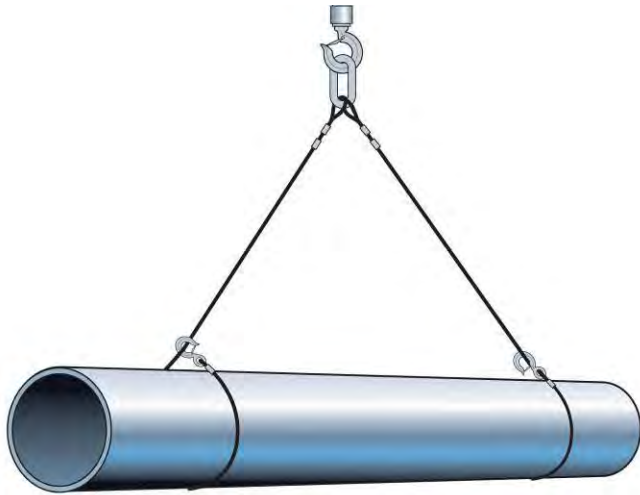

### 3-Leg Slings Share the Whole Load

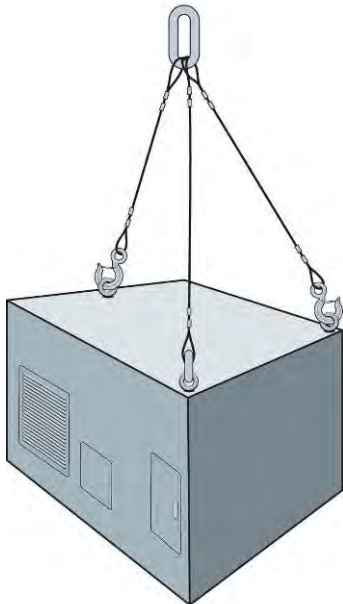

### 4-Leg Slings: 2 Legs Carry Most of the Load

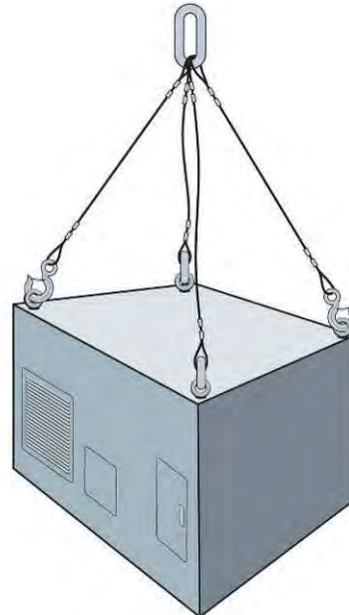

## Rule # 4—Select the Right Sling Based on Load Type

There are several different types of slings to choose from. The slings used most frequently in the mechanical industry are synthetic web slings, synthetic round slings, wire rope slings, and alloy steel chain slings. A critical consideration in sling selection is the relationship between the rated capacities of the sling and the type of hitch you plan to use. The rated capacity of a sling used with a vertical hitch will be different if you use the same sling with a choker hitch or a basket hitch. For example:

### Synthetic Round Sling

Rated capacities for a specific brand and model of synthetic web sling:

Hitch Type	Rated Capacity	What to Look for
Vertical	8,400 pounds	
Choker	6,720 pounds	
Basket	16,800 pounds	

### Wire Rope Sling

Rated capacities for a specific brand and model of wire rope sling:

Hitch Type	Rated Capacity	What to Look for
Vertical	2,800 pounds	
Choker	2,200 pounds	
Basket	5,600 pounds	

When selecting a sling for a particular application, ask yourself:

1. Is the sling compatible with the hitch you will use to perform the lift safely?
2. Does the design and composition of the sling make it strong enough to perform the work safely (rated capacity)? Remember to consider **reductions** for sling angles and the type of hitch you will be using.



3. Is the sling in good condition?
4. Will the sling keep the load secure and stable?
5. Is the sling compatible with the rigging hardware?
6. Could the specific rigging/lifting application cause the sling to break or otherwise become damaged during the lift?
7. Could the sling damage the materials or equipment that is to be rigged/lifted?

## Synthetic Web Slings

Considerations	What to Look for
<p>Rated capacity.</p> <p>Protection from sharp edges.</p> <p>Strength largely depends on the size of the sling.</p> <p>Great for temporary work such as mechanical construction and service work.</p>	

## PROS

- Forms easily to the shape of the load.
- Provides a non-slip grip on the load.
- Less likely to damage delicate loads such as HVAC units.
- Less likely to scratch loads with polished surfaces such as HVAC units.
- Can absorb a lot of shock without being damaged.
- Rated capacity is unaffected by abnormally hot air temperatures.
- Unaffected by mildew.
- Resistant to some chemicals.
- Long service life.

## CONS

- Can burn from exposure to acids or caustics.
- Can melt or char from contact with flames/extremely hot heat sources.
- Susceptible to cuts from sharp objects.
- Stitching can break.

## Synthetic Round Slings

Considerations	What to Look for
<p>Rated capacity.</p> <p>Protection from sharp edges.</p> <p>Strength largely depends on the size of the sling.</p>	

## PROS

- Forms easily to the shape of the load.
- Unlikely to damage delicate loads such as HVAC units.
- Unlikely to scratch loads with polished surfaces such as HVAC units.
- Rated capacity is unaffected by abnormally hot air temperatures.
- Unaffected by mildew.
- Resistant to some chemicals.
- Long service life.

## CONS

- Can burn from exposure to acids or caustics.
- Can melt or char from contact with flames/extremely hot heat sources.
- Susceptible to cuts from sharp objects.
- Exposure and/or damage to core yarns render these slings ineffective/defective.

## Wire Rope Slings

Considerations	What to Look for
<p>Strength, i.e. diameter, grade and construction (rated capacity).</p> <p>Prevent fatigue failure (small cracks) by using blocking or padding to increase the size of the radius in bends.</p>	

### PROS

- With Wire Rope Core - Tend to be strong and somewhat resistant to heat.
- With Fiber Core – Tend to be flexible.

### CONS

- With Fiber Core – somewhat vulnerable to environmental conditions.
- Subject to kinking, which weakens wire rope.
- Subject to tiny cracks from small radius bends, which weakens wire rope.
- Wire rope made with smaller wires is more susceptible to abrasive wear.

## Alloy Steel Chain Slings

Considerations	What to Look for
<p>Rated capacity.</p> <p>Rigging/lifting conditions.</p> <p>Type of load to be rigged/lifted.</p>	

### PROS

- Strong and durable.
- Perform very well in harsh environments.

## CONS

- Sudden jerks can weaken or break them.
- Chain links can stretch weakening steel chain slings.
- Susceptible to other types of damage such as rust, nicks, and gouges, all of which can weaken the sling.
- Can damage delicate loads.

## Rule # 5 – Select the Right Hardware for the Load

Selecting the right hardware for each specific rigging application is just as important as selecting the right slings. Hooks, shackles, eyebolts, and U-bolt wire rope clips are among the most frequently used rigging hardware in our industry. While there are several different types of hardware in these categories, the selection process is the same for hooks, shackles and eyebolts. They are rated based on straight, linear tension. Be aware that the rated capacity changes when angles are involved just like it does when using slings. When selecting hardware for a particular application ask yourself:

1. Do the design and composition of the hardware make it strong enough to perform the work safely (rated capacity)? When asking yourself this question, remember to consider reductions for hardware that will be used in angular situations.
2. Will the hardware keep the load secure?
3. Is the hardware compatible with the sling?
4. Is the hardware in good condition?
5. Could the hardware damage the materials or equipment that is to be rigged/lifted?

### General

- Capacity tables should be used only for pre-project planning purposes.
- Rated capacities of the same sizes and types of hardware may be significantly different from one manufacturer to another. For example, the rated capacity of a 7/8" eyebolt made by one manufacturer may be several hundred pounds different than the rated capacity for a 7/8" eyebolt made by a different manufacturer.
- When selecting hardware, always use the rated capacity provided by the manufacturer specifically for that piece of hardware.

## Hooks



- Hooks used on center (straight up and down with a balanced load) can carry 100 percent of the rated load.
- Hooks that are off center cannot carry 100 percent of the rated load. The percentage of the rated load a hook can safely carry depends on how far the hook is off center.
- Identification markings should be shown on each hook. If they are not shown, or if you cannot read them, do not use the hook. Take it out of service immediately and permanently.

## Shackles



- Identification markings should be shown on each shackle. If they are not shown, or if you cannot read them, do not use the shackle. Take it out of service immediately and permanently.

## Eye Bolts



- Identification markings should be shown on each eyebolt. If they are not shown, or if you cannot read them, do not use the eyebolt. Take it out of service immediately and permanently.

## Wire Rope Clips

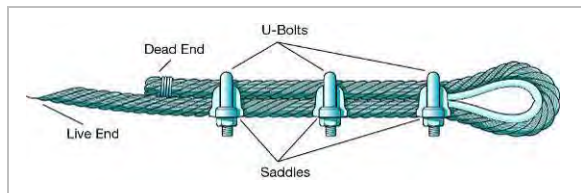

- Proper positioning of wire rope clips is critical to their performance. The attachment piece that slides over both threaded ends of the U-bolt is referred to as the “Saddle.” Remember the phrase, “Never saddle a dead horse.” That means the saddle should always be placed over the live side of the wire rope. When you bend the rope to attach wire rope clips, the live side is the side *opposite* the end of the wire rope.
- Be sure not to stagger wire rope clips. To do so, you would have to inappropriately, “saddle a dead horse.”
- Be wary of wire rope slings made with wire rope clips. If you do not know whether the sling has been approved for the specific application by a qualified engineer, do not use it. Take it out of service immediately until it can be inspected by a qualified engineer.

## Rule # 6—Inspect Each Sling Before You Use It

Rigging slings wear out over time and become dangerous when they can no longer safely support their rated capacity. Sling inspections are critical and should be performed before each use.

### Procedure for Handling Defective Equipment

- When you come across a defective sling destroy it immediately in accordance with our company policy.
- If you are not sure whether any part of the sling is safe to use, do not use it. Put a **“Danger Do Not Use”** tag on it and take it out of service until a properly trained/qualified person can inspect it and determine whether it is safe to use.

### Synthetic Web Slings



### INSPECTIONS

- Look for permanently attached identification on each sling. The information should include the manufacturer’s name or trademark, the manufacturer’s code number or stock number, the rated capacities based on the three basic types of hitches, the angles on which the capacities are based, the type of core material that makes up the sling, and the type of cover material, if different than the core material.
- Carefully inspect synthetic web slings inch by inch to ensure that any damaged areas are identified.
- Check for melting or charring that would indicate exposure to excessive heat or flames, rendering the sling defective.
- Look for cuts, tears, snags or any other fiber damage, which would render the sling defective.
- Carefully observe the stitching throughout the sling looking for broken and worn stitching, which would render the sling defective.



- Check for abraded areas, especially where the sling would rub against the load, a fitting, or other hardware, rendering the sling defective.
- Make sure there are no knots in the sling. If a sling has been used with a knot, consider it defective since a knot can permanently weaken the sling.
- If the sling is discolored, look closely for brittle fibers and hardened areas caused by excessive heat or chemicals, which would render the sling defective.
- Carefully inspect any permanently attached fittings. If you discover a fitting that is rusted, corroded, bent, cracked, gouged, worn or has sharp edges that could cut the fiber webbing, the sling is defective.

Any defective sling should be destroyed immediately in accordance with your company policy. If you find any indication that any part of a sling may be defective, or if you are not sure, take it out of service immediately and follow the procedure for handling defective equipment.

## Synthetic Round Slings

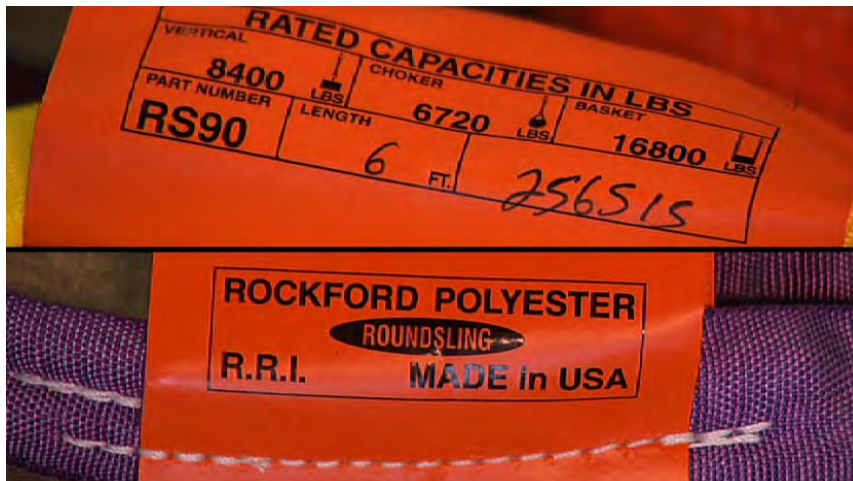

## INSPECTIONS

- Look for permanently attached identification on each sling. The information should include the manufacturer's name or trademark, the manufacturer's code number, or stock number, the rated capacities based on the three basic types of hitches, the angles on which the capacities are based, the type of core material that makes up the sling, and the type of cover material if different than the core material.
- Carefully inspect synthetic round slings inch by inch to ensure that any damaged areas are identified.
- Look for cuts, tears, snags, burns or any other signs of damage that leave the core yarns exposed or damaged, rendering the sling defective.
- Check the sling over carefully for acid and caustic burns that would render the sling defective.

- Look for abraded areas, especially where the sling would rub against the load, a fitting, connector or other hardware, rendering the sling defective.
- Make sure there are no knots in the sling. If a sling has been used with a knot consider it defective since a knot can permanently weaken the sling.
- If the sling is discolored, look closely for brittle fibers and hardened areas caused by excessive heat or chemicals, which would render the sling defective.
- Carefully inspect any permanently attached fittings. If a fitting is rusted, corroded, bent, cracked, gouged, worn or has sharp edges that could cut the sling it is defective.

Any defective sling should be taken out of service. If you find any indication that any part of a sling may be defective, or if you are not sure, take it out of service immediately and follow the procedure for handling defective equipment.

## Wire Rope Slings

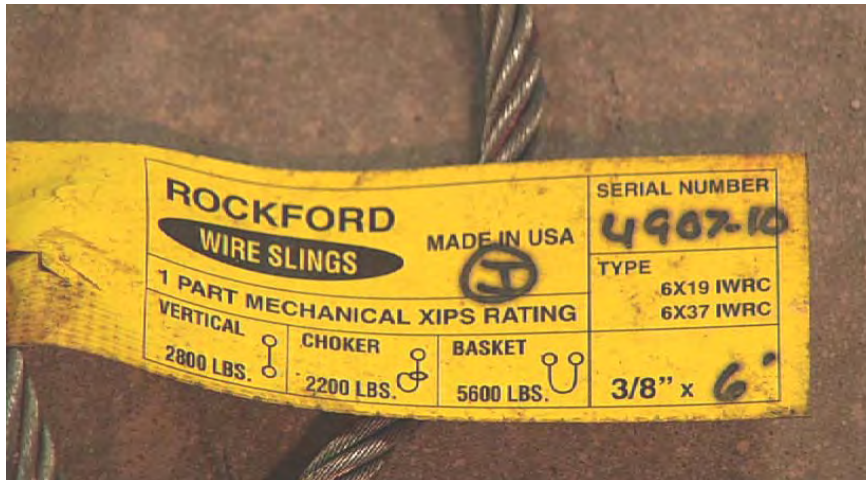

## INSPECTIONS

- Look for permanently attached identification on each sling that states the size, grade, rated capacity and the name of the manufacturer. If the identification tag is not attached, the sling is defective.
- Carefully inspect wire rope slings inch by inch to ensure that any damaged areas are identified.
- Look for broken wires. If there are five or more broken wires in one rope lay the sling is defective. If there are three or more broken wires in one strand of one rope lay the sling is defective. A rope lay is the length along the rope where one strand makes a complete revolution around the rope (See Appendix A). (Note: Some companies consider wire rope slings to be defective when a single wire is broken. Be sure you are familiar with your company's policy regarding wire rope slings.)
- Examine the areas of wire rope that are close to attached fittings. If there is one or more broken wires in any of these areas the sling is defective.

- Look for worn and abraded wires that would render the sling defective.
- Check to determine whether the wire rope has stretched beyond its normal capacity. If the rope diameter has decreased or the length of a rope lay has increased, the wire rope may be defective and requires further inspection by a properly trained/qualified person before use.
- Look carefully for signs of corrosion, rust, pitting and discoloration. If you detect corrosion on the outside of the wire rope it may have corrosion inside where you cannot see it. Consider it defective.
- Check the end connections, including thimbles, for damage and wear. If you identify cracks, bends, excessive wear or improperly applied end connections, the sling is defective.
- Look at the strands of the wire rope. If a strand is sticking up away from the rest of the rope, the sling is defective.
- Watch for “bird caging.” When wire rope strands begin to unravel or push out away from other strands leaving gaps, the sling is defective.
- Check for heat damage, such as melted areas and burn marks. If you detect heat damage the sling is defective.

Any defective sling should be taken out of service. If you find any indication that any part of a sling may be defective, or if you are not sure, take it out of service immediately and follow the procedure for handling defective equipment.

## Alloy Steel Chain Slings



## INSPECTIONS

- Look for a permanently attached identification tag on each sling that states the size, grade, rated capacity and the name of the manufacturer. If the identification tag is not attached, the sling is defective.
- Only Alloy Grades 80 or 100 may be used for overhead lifting. If the sling does not meet these criteria, take it out of service immediately.

# RIGGING SAFETY GUIDE

- Carefully inspect each link and hook for bends, cracks, gouges and any other marks that show excessive wear rendering the sling defective.
- Check the links to determine whether they have stretched. Pay close attention to where the links are pulled and rubbed against each other and the eye of the hook. If links are binding against each other or binding against the eye of the hook, the links have stretched, rendering the sling defective.
- If the sling has several legs, hang it up to determine whether all the legs are the same length. If one or more legs do not match others, the sling is defective.

Any defective sling should be destroyed immediately in accordance with your company policy. If you find any indication that any part of a sling may be defective, or if you are not sure, take it out of service immediately and follow the procedure for handling defective equipment.

## Rule # 7—Inspect Rigging Hardware Before You Use It

Rigging hardware can wear out over time. It can weaken and break from wear, misuse, and/or abuse. It becomes dangerous when it can no longer safely support its rated capacity. Hardware inspections are critical and should be performed before each use.

### Procedure for Handling Defective Equipment

- When you come across defective hardware destroy it immediately in accordance with your company policy.
- If you are not sure whether the hardware is safe to use, do not use it. Put a **“Danger Do Not Use”** tag on it and take it out of service until a properly trained/qualified person can inspect it and determine whether it is safe to use.

### Rigging Hardware - Hooks, Shackles, Eye Bolts

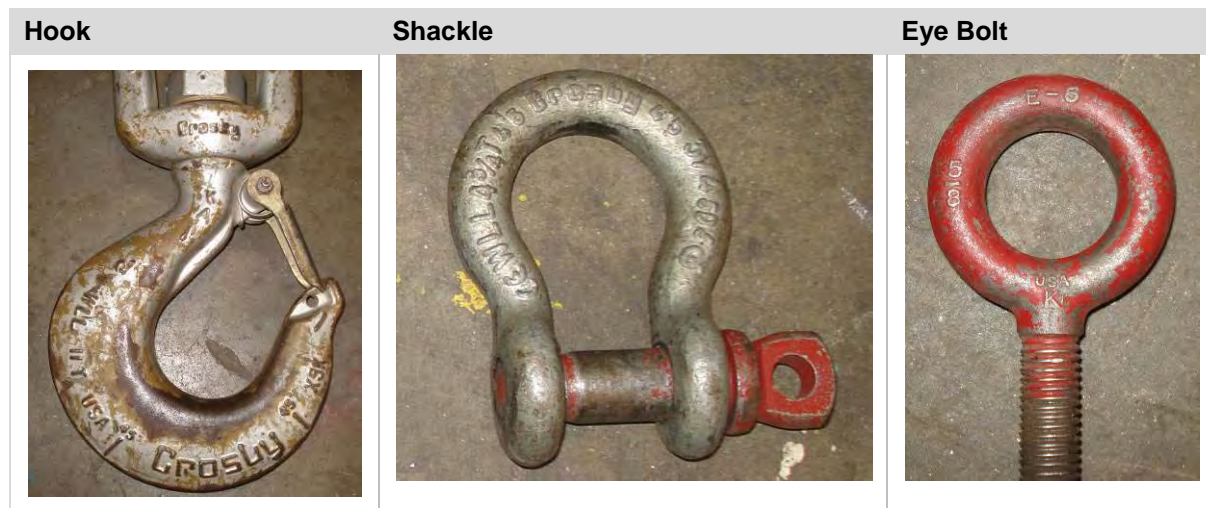

### INSPECTIONS

- Look for identification markings on the hardware. If the identification information is missing or illegible, the hardware is defective.
- Check the hardware carefully for cuts, gouges, corrosion, rust (other than surface rust), and pitting. If any of these defects are present and appear significant, or if you are not sure whether the hardware is safe to use, consider it defective.
- Check each piece carefully for melted areas, welding arc strikes, welding slag or other hot work markings. If any of these defects are present and appear significant, or if you are not sure whether the hardware is safe to use, consider it defective.
- Pay special attention to the area of the hardware that bears most of the weight of the load.
- Look for bent, twisted, stretched, cracked and broken areas on hardware, which render the hardware defective.

# RIGGING SAFETY GUIDE

- Carefully check hardware pieces that include pins. If the threads appear damaged or stripped, the pin does not thread/seat properly, or the pin appears stretched or damaged in any way, it is defective.
- Look for any other types of damage to hardware that would render it defective.

Any defective hardware should be taken out of service. If you find any indication that any part of the hardware may be defective, or if you are not sure whether it is safe to use, take it out of service immediately and follow the procedure for handling defective equipment.

## Rule # 8—Protect Slings from Cuts and Tears

All types of slings should be protected from sharp edges, especially synthetic web slings, which are most susceptible to cuts. To protect the slings, place padded material between the sling and the edges. Make sure the material is strong enough to withstand the increased force of the sharp edges against it when the load is lifted.

### General

- The edges of the material being lifted do not have to be razor sharp to cut a sling that is not properly protected.
- Wide synthetic web slings are particularly susceptible to tearing at their points of contact with the corners of the load.
- Consider using commercial softeners for padding, or consider using commercial corner protectors that force the sling to round out at the contact points.

## Rule # 9—Determine the Load’s Center of Gravity

Center of gravity is the point within the load at which the object balances evenly in all directions. To ensure safe rigging it is important to identify the center of gravity so that the load will remain stable throughout the lift. The load should be raised directly above the center of gravity whenever possible.

It is easy to determine the center of gravity on objects that are uniform in shape and composition such as a single piece of pipe. However, oddly configured objects require more trial and error to determine the center of gravity. Once you have finished rigging the load, have the operator carefully raise the load a few inches at a time, stopping and starting slowly so you can determine whether the rigging needs to be adjusted. If the load tilts during the trial, signal the operator to set it back down, and then re-rig the load. Follow this procedure as many times as necessary until the load is stable.

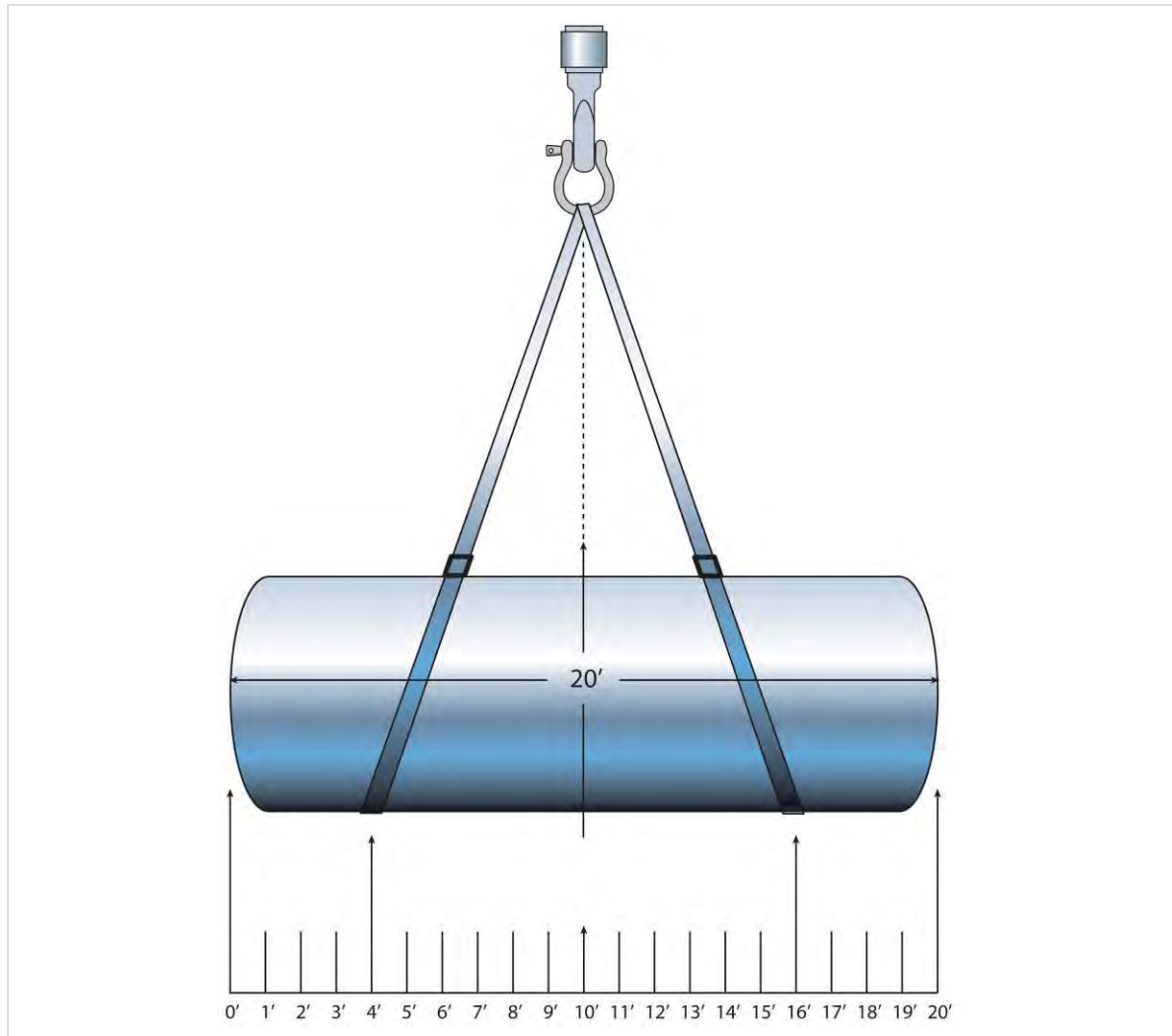



## Rule # 10 – Pay Close Attention to Detail at Lift Time

Just before and during the lift there are several details that require special attention, including testing the load, attaching tag lines, identifying potential obstructions, clearing the area, and communicating with the operator.

### Testing the Load

When you have finished the initial rigging of the load, signal the operator to slowly raise it a few inches so that you can make adjustments when necessary.

- Ensure that the sling stays in the correct position as it tightens around the load.
- Watch for potential sling and hardware failures.
- Make sure the load is being raised straight up over its center of gravity so the load will not swing.
- Be aware of potential pinch points and keep your hands and body clear.
- Also, be aware that the load could shift as it is lifted. Position your body so that you will not be trapped or crushed if the load does shift.

If you detect any issues, or if you are not sure whether the load can be lifted safely, signal the operator to set it back down and re-rig the load before testing it again.

### Tag Lines

- Tag lines should be attached to the load to keep it from rotating and swinging out of control during the lift.
- Use the number of tag lines and properly trained tag line operators that are necessary to control the load safely.
- Make sure that all tag line operators and anyone else in the lift area is wearing a hardhat.

### Potential Obstructions

- Consider where the load needs to be delivered in relation to where it is before the lift.
- Look for any obstructions that may be in the path of the moving load.
- Pay special attention to overhead power lines when watching for obstructions.
- If you detect a potential obstruction, check with the operator to ensure that he is aware of the obstruction and has chosen a safe path for the load to travel.

### Clear the Area

- Be sure to clear the lift area and areas under the path the load will travel as much as possible right before the lift.
- Establish a signal for workers in the area so that they will know when a lift is about to occur. The operator can use the equipment's air horn to make the signal or another type of signal can be established.

## Communication with the Operator

- No matter what type of communication has been established between the rigger and the operator it is a good idea for the rigger and operator to know the standard hand signals for lifting operations. That way if voice communication breaks down they can still communicate effectively.
- If communication with the operator will take place by voice, the rigger and the operator need to know the same standardized set of verbal signals.
- Regardless of what type of communication will take place, make certain that only one person is assigned to communicate with the operator and that all other workers involved in the rigging/lifting process know who that person is.
- See Appendix C for standard hand signals for crane operations.

## Appendix A—Safety Tips for Common Industry Rigging Applications

### Sling Safety Tips

*Never tie two or more slings together.*

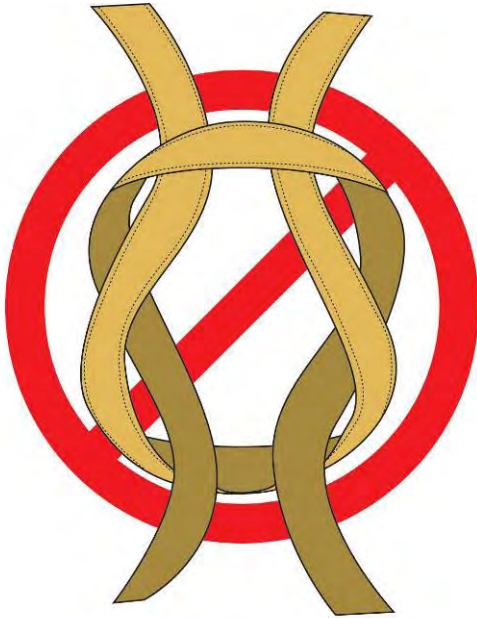

*Always connect two slings with a shackle.*

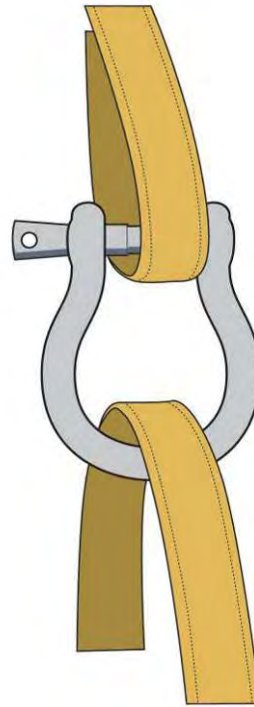

**Never attach a sling directly to a lifting lug.**

**Be sure to choke below the threads on synthetic web slings.**

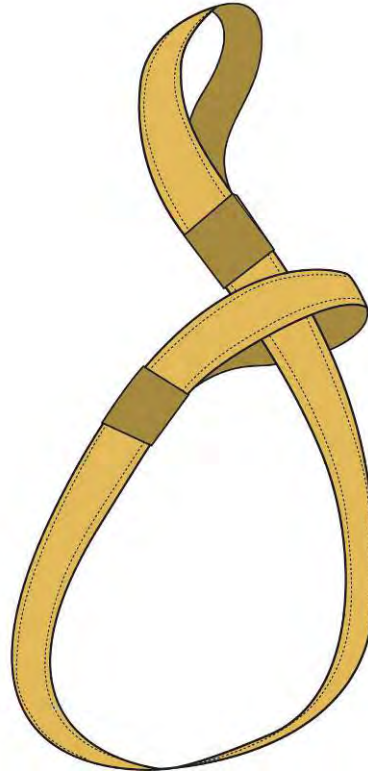

## Wire Rope Safety Tips

***A wire is defective if there are 5 or more broken wires in one rope lay and/or 3 or more broken wires in 1 strand of one rope lay.***

***1 rope lay is the length it takes for a single strand to wrap completely around the core one time.***

***Never run a sling directly through the lifting lugs/eyebolts.  
(Doing so creates too much tension.)***

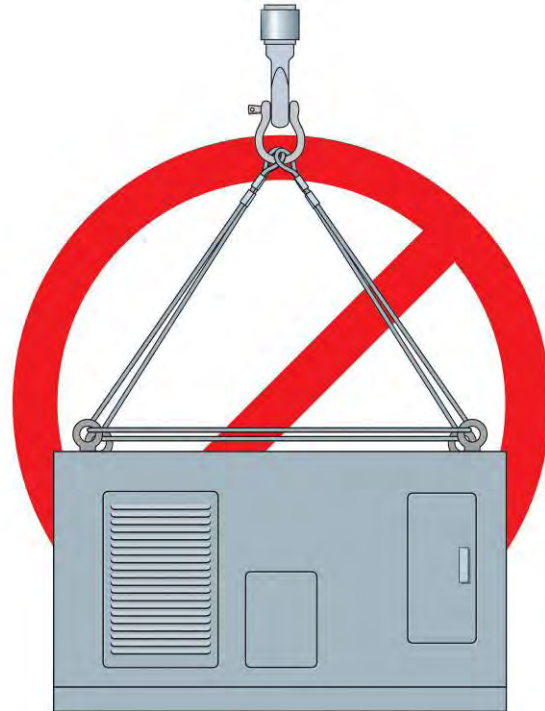

***“Never saddle a dead horse.”***

*The saddle always goes on the “live” end of the wire rope.*

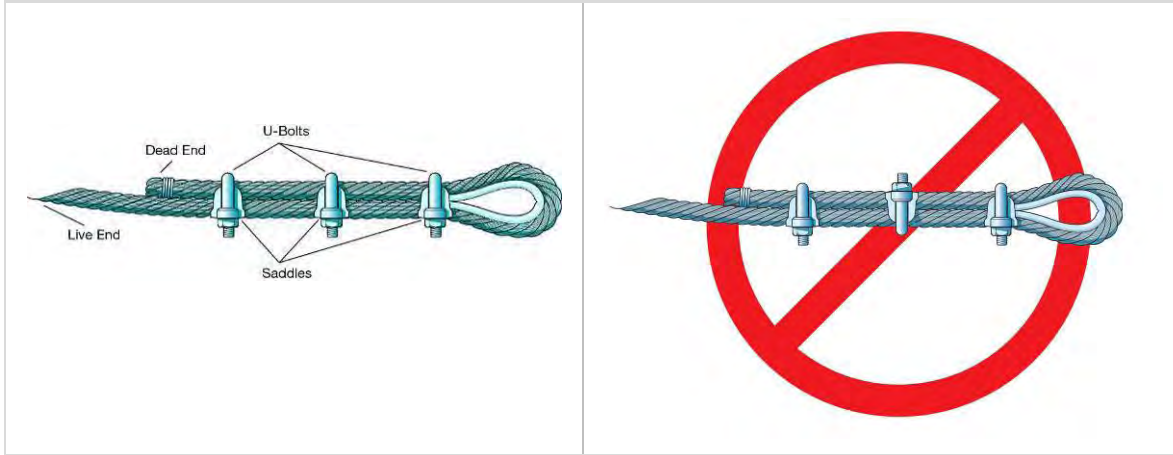

Number and Spacing of U-Bolt Wire Rope Clips			
Improved plow steel rope diameter (inches)	Number of clips		Minimum Spacing (inches)
	Drop forged	Other material	
1/2 (1.27 cm)	3	4	3 (7.62 cm)
5/8 (1.588 cm)	3	4	3 3/4 (9.525 cm)
3/4 (1.905 cm)	4	5	4 1/2 (11.43 cm)
7/8 (2.223 cm)	4	5	5 1/4 (13.335 cm)
1 (2.54 cm)	5	6	6 (15.24 cm)
1 1/8 (2.858 cm)	6	6	6 3/4 (17.145 cm)
1 1/4 (3.175 cm)	6	7	7 1/2 (19.05 cm)
1 3/8 (3.493 cm)	7	7	8 1/4 (20.955 cm)

### Shackle Safety Tips

**Never allow the sling to bunch up on the shackle.**

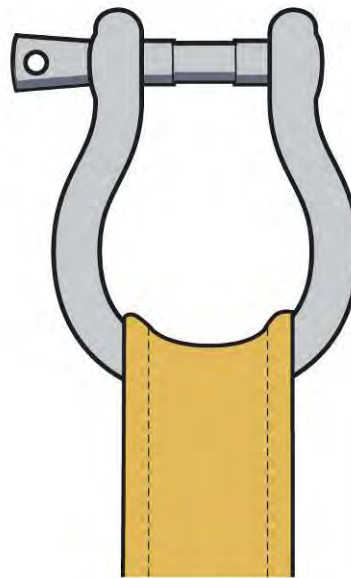

## Always use the right size shackle

**Example: 1" shackle and 1 1/2" wire rope**

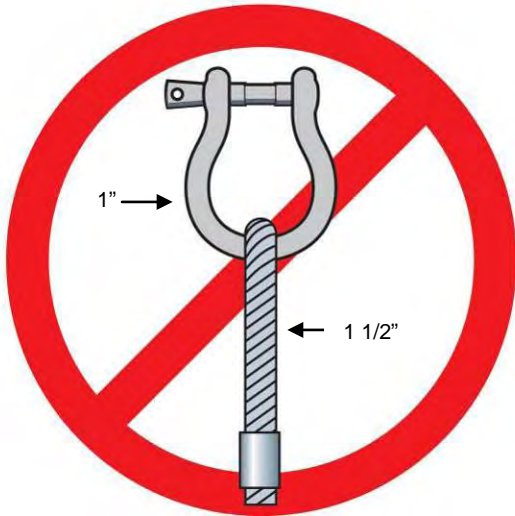

**Example: 2" shackle and 1 1/2" wire rope**

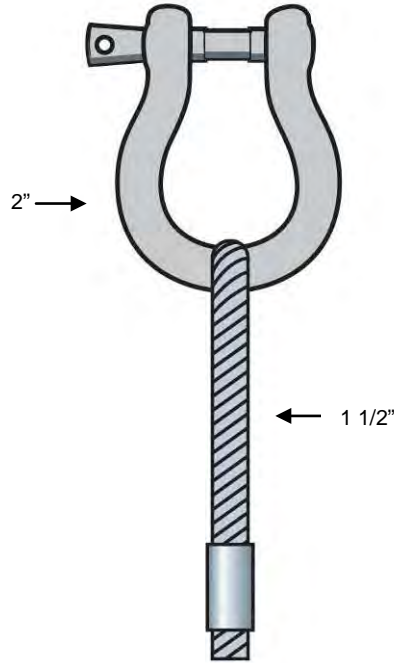

## Shackle to Shackle Connection

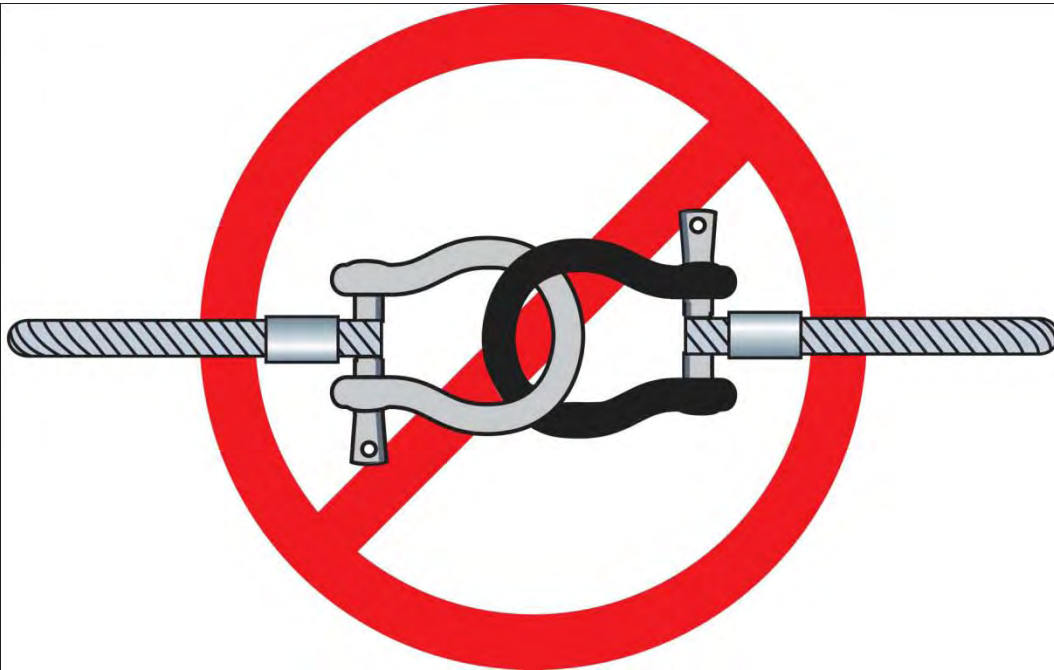



**Single Leg Slings/Vertical Hitch—Either shackle orientation is safe**

**Use washers to keep hook centered on shackle pin when necessary.**



## Shackle Orientations



*Too much tension on shackle ears.*

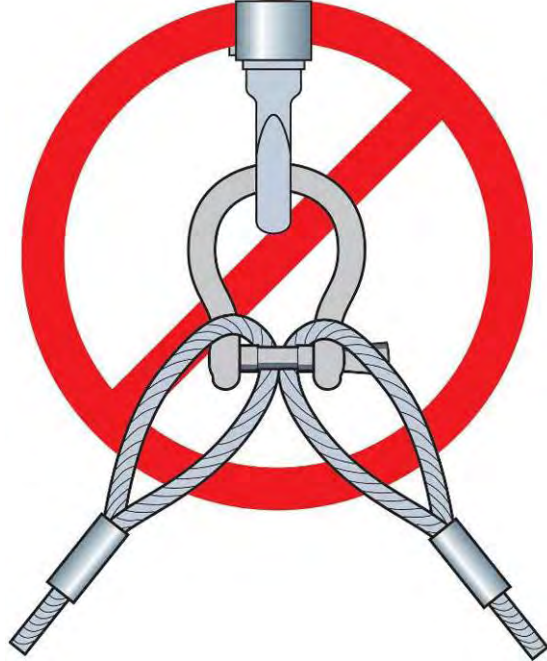
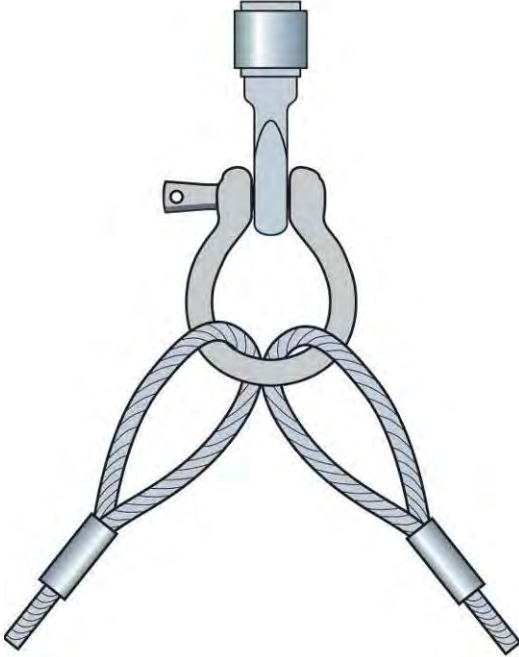

*Shackle pin can become unscrewed.*

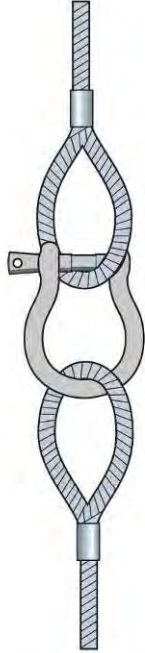

*Shackle pin can become unscrewed.*

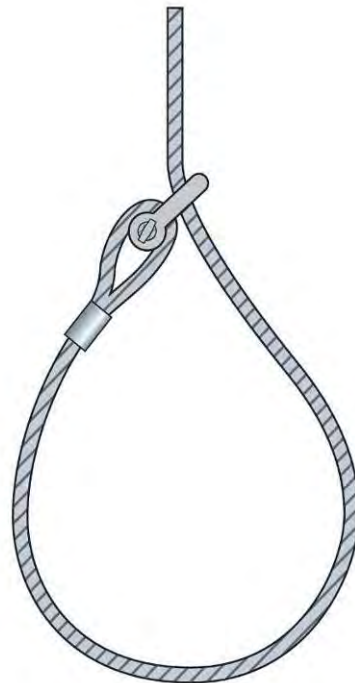

## Hook Safety Tips

**Be sure to use the right size sling for the size of the hook.**

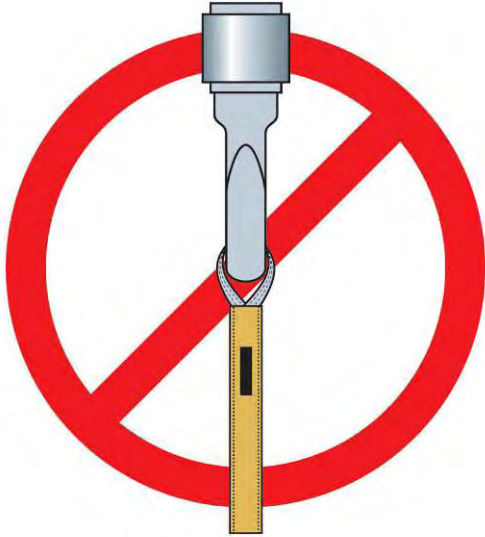

**Be sure not to point load hooks.**

(Continuous reduction in percentage of rated capacity as the angle is increased and the load moves out from the center of the hook)

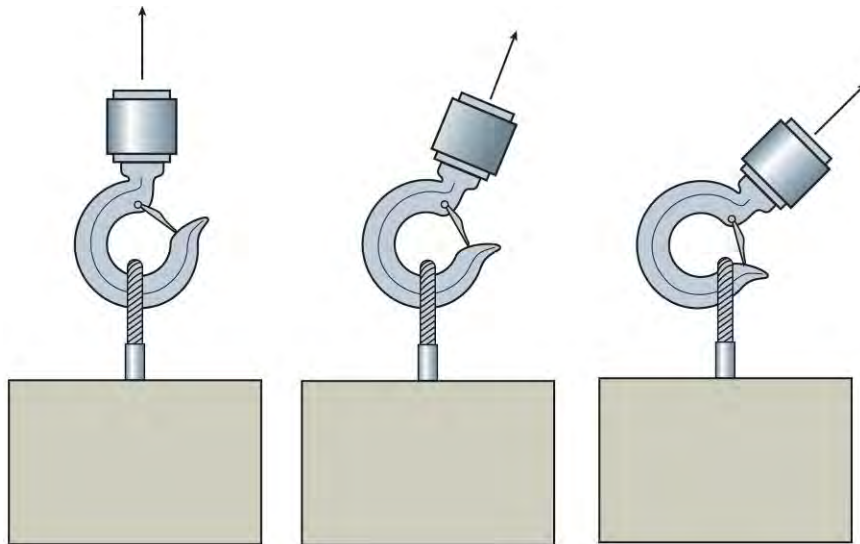

## Eye Bolt Safety Tips

(Continuous reduction in percentage of rated capacity as the angle is increased.)

100% of Rated Capacity

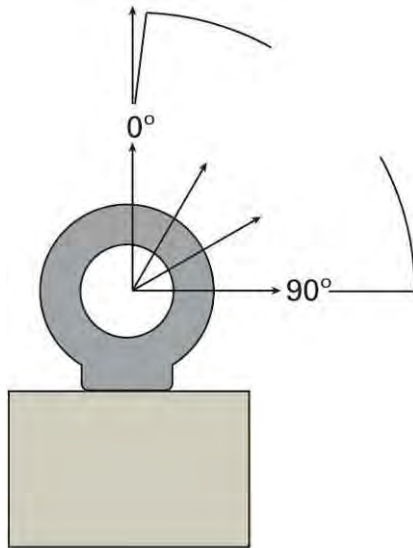

*To keep from having to calculate eye bolt rated capacity reductions, use spreader bars or rigging beams to keep the lift 100 percent vertical.*

***Eye bolts that are not seated all the way to the shoulder should not be used for angular lifts.***

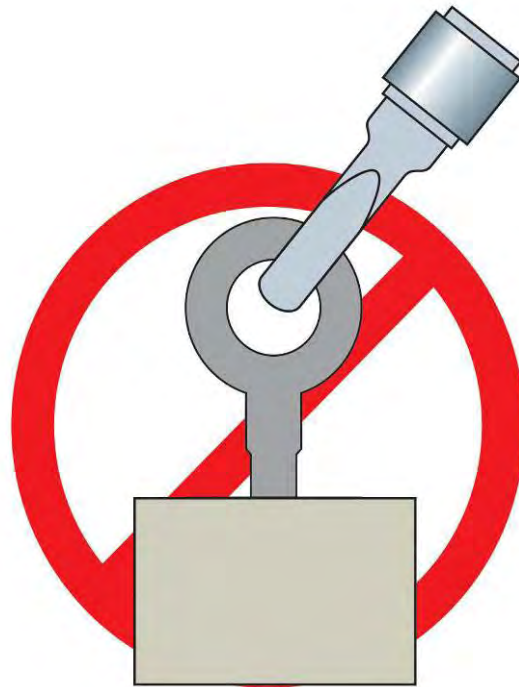
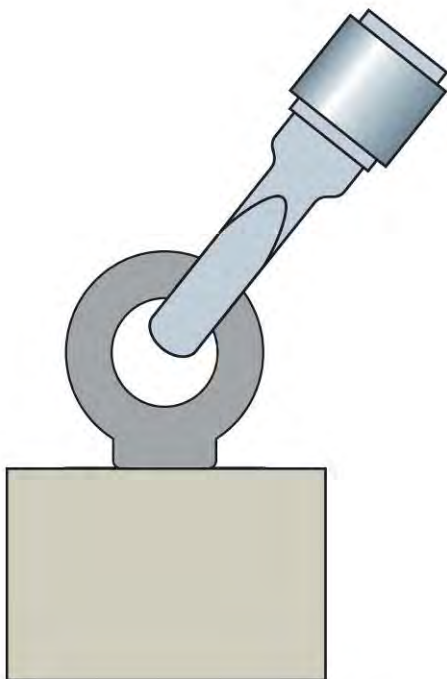



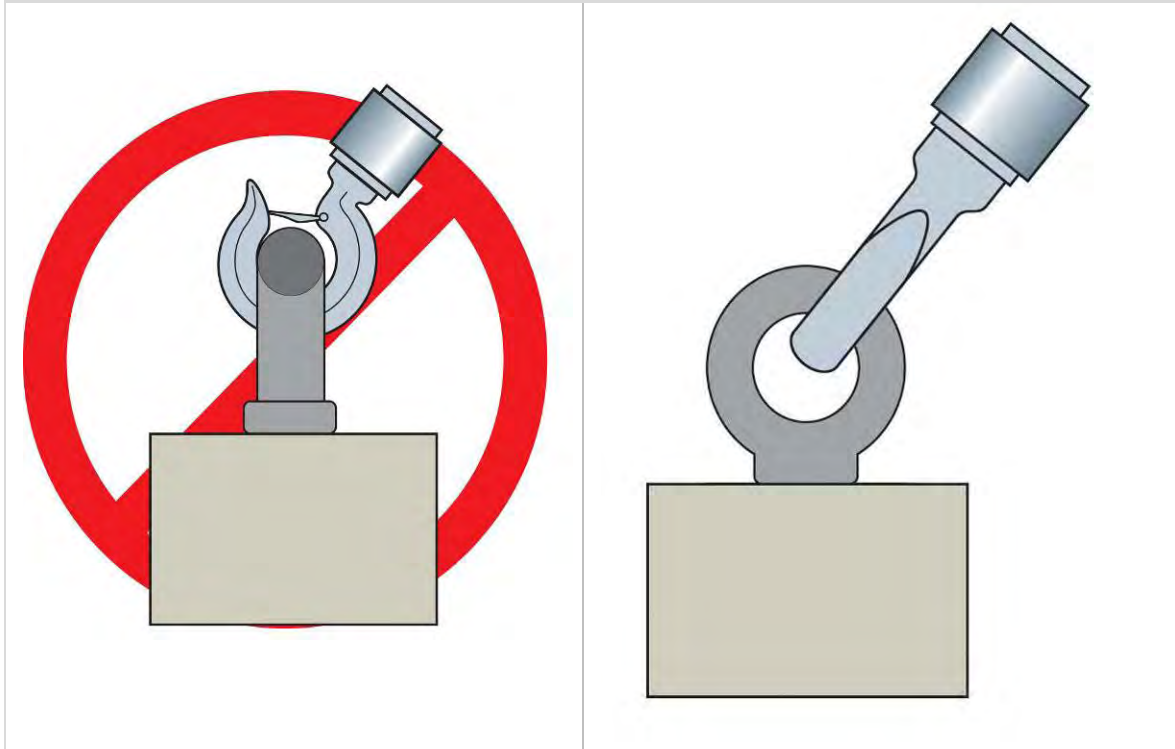

## Eye bolt orientations

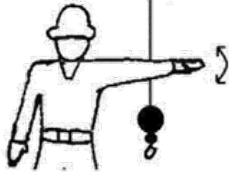
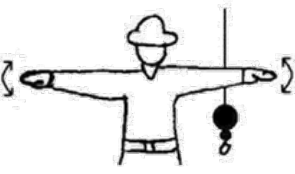

## Appendix B—Pre-Lift Reminders for Riggers

- Check the weather conditions before the lift. If the weather is extreme, postpone the lift.
- Make sure you have good communication in place with the lift equipment operator.
- Check the area for power lines and other obstructions.
- Wear a hardhat and sturdy work gloves when rigging.
- Rig the load so that it will be lifted straight up, which will help prevent the load from swinging.
- Guide the operator to place the boom directly over the load, which will help prevent the load from swinging.
- Make sure your hands are clear of pinch points when the sling starts to tighten around the load.
- Watch carefully when the lift starts in case the load does swing.
- Be sure to stay out from under the load when it is being lifted and moved.
- Use one or more tag lines to control the load.
- Make sure the receiving area is firm, flat, and free from loose objects that could fly up when the load is delivered. And, make sure the area is free from other obstructions.
- Signal the operator to deliver the load slowly.
- Guide the load onto the blocking so that it will not be dislodged.
- Watch the placement of your feet when you receive the load.
- Give the stop signal immediately if something does not appear to be safe.

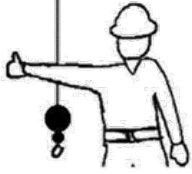
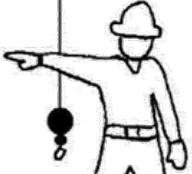
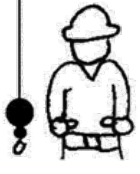
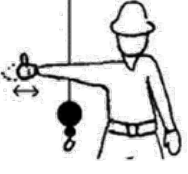
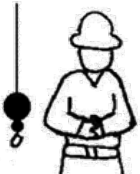

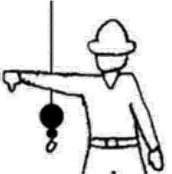
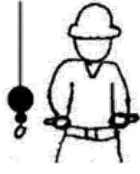
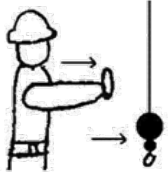

## Appendix C—Hand Signals for Crane Operations

 <p><b>STOP</b> – With arm extended horizontally to the side, palm down, arm is swung back and forth.</p>	 <p><b>EMERGENCY STOP</b> – With both arms extended horizontally to the side, palms down, arms are swung back and forth.</p>	 <p><b>HOIST</b> – With upper arm extended to the side, forearm and index finger pointing straight up, hand and finger make small circles.</p>
 <p><b>RAISE BOOM</b> – With arm extended horizontally to the side, thumb points up with other fingers closed.</p>	 <p><b>SWING</b> – With arm extended horizontally, index finger points in direction that boom is to swing.</p>	 <p><b>RETRACT TELESCOPING BOOM</b> – With hands to the front at waist level, thumbs point at each other with other fingers closed.</p>
 <p><b>RAISE THE BOOM AND LOWER THE LOAD</b> – With arm extended horizontally to the side and thumb pointing up, fingers open and close while load movement is desired.</p>	 <p><b>DOG EVERYTHING</b> – Hands held together at waist level.</p>	 <p><b>LOWER</b> – With arm and index finger pointing down, hand and finger make small circles.</p>
 <p><b>LOWER BOOM</b> – With arm extended horizontally to the side, thumb points down with other fingers closed.</p>	 <p><b>EXTEND TELESCOPING BOOM</b> – With hands to the front at waist level, thumbs point outward with other fingers closed.</p>	 <p><b>TRAVEL/TOWER TRAVEL</b> – With all fingers pointing up, arm is extended horizontally out and back to make a pushing motion in the direction of travel.</p>

*Continued on the following page*

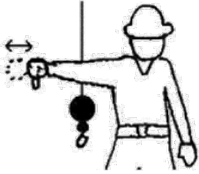

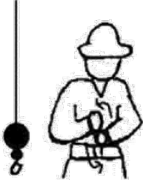
Continued from the previous page

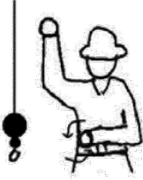
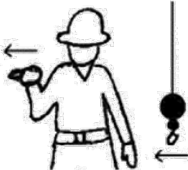
 <p><b>LOWER THE BOOM AND RAISE THE LOAD</b> – With arm extended horizontally to the side and thumb pointing down, fingers open and close while load movement is desired.</p>	 <p><b>MOVE SLOWLY</b> – A hand is placed in front of the hand that is giving the action signal.</p>	 <p><b>USE AUXILIARY HOIST (whipline)</b> – With arm bent at elbow and forearm vertical, elbow is tapped with other hand. Then regular signal is used to indicate desired action.</p>
 <p><b>CRAWLER CRANE TRAVEL, BOTH TRACKS</b> – Rotate fists around each other in front of body; direction of rotation away from body indicates travel forward; rotation towards body indicates travel backward.</p>	 <p><b>USE MAIN HOIST</b> – A hand taps on top of the head. Then regular signal is given to indicate desired action.</p>	 <p><b>CRAWLER CRANE TRAVEL, ONE TRACK</b> – Indicate track to be locked by raising fist on that side. Rotate other fist in front of body in direction that other track is to travel.</p>
 <p><b>TROLLEY TRAVEL</b> – With palm up, fingers closed and thumb pointing in direction of motion, hand is jerked horizontally in direction trolley is to travel.</p>		



Item Code: SE 69PDF



**Mechanical Contractors Association of America, Inc.**

1385 Piccard Drive • Rockville, MD 20850-4340

301-869-5800 • Fax 301-990-9690 [www.mcaa.org](http://www.mcaa.org)